

**Part Number: PT413-74111**

**NOTE:** Part number of this accessory may not be the same as the part number shown.

**Kit Contents**

Item #	Quantity Reqd.	Description
1	1	Fog Light Bezel, Left Side
2	1	Fog Light Bezel, Right Side
3	1	Fog Lamp, Left Side
4	1	Fog Lamp, Right Side
5	1	Hardware Kit

**Hardware Bag Contents**

Item #	Quantity Reqd.	Description
1	2	#10-16 Hex Head Self-Tapping Screw
2	1	Switch
3	1	Relay

**Additional Items Required For Installation**

Item #	Quantity Reqd.	Description
1	1	Ratchet
2	1	10mm Socket (or Nut Driver)
3	1	8mm Socket
4	1	Nylon pry-tool
5	1	Torque Wrench

**Conflicts**

--

**Recommended Tools**

<b>Personal &amp; Vehicle Protection</b>	<b>Notes</b>
Vehicle Protection	Blankets 1" Wide Masking Tape
<b>Special Tools</b>	<b>Notes</b>
Hella Photometric Beam Setter (or equivalent)	If available
Nylon pry-tool	
Car Lift or Jack with Jack Stands	
<b>Installation Tools</b>	<b>Notes</b>
Ratchet	
Socket or Nut Driver	10mm
Socket	8mm
Torque Wrench	5.4 N-M ( 48 in=lb)
<b>Special Chemicals</b>	<b>Notes</b>
none	

**General Applicability**

Scion iQ
----------

**Recommended Sequence of Application**

Item #	Accessory
1	
2	
3	
4	
5	
6	

**Vehicle Service Parts** (may be required for reassembly)

Item #	Quantity Reqd.	Description
1		

**Legend**



**STOP:** Damage to the vehicle may occur. Do not proceed until process has been complied with.



**OPERATOR SAFETY:** Use caution to avoid risk of injury.



**CAUTION:** A process that must be carefully observed in order to reduce the risk of damage to the accessory/vehicle and to ensure a quality installation.



**TOOLS & EQUIPMENT:** Used in Figures calls out the specific tools and equipment recommended for this process.



**REVISION MARK:** This mark highlights a change in installation with respect to previous issue.

Care must be taken when installing this accessory to ensure damage does not occur to the vehicle. The installation of this accessory should follow approved guidelines to ensure a quality installation.

These guidelines can be found in the "Accessory Installation Practices" document.

This document covers such items as:-

- Vehicle Protection (use of covers and blankets, cleaning chemicals, etc.).
- Safety (eye protection, rechecking torque procedure, etc.).
- Vehicle Disassembly/Reassembly (panel removal, part storage, etc.).
- Electrical Component Disassembly/Reassembly (battery disconnection, connector removal, etc.).

Please see your Toyota dealer for a copy of this document.

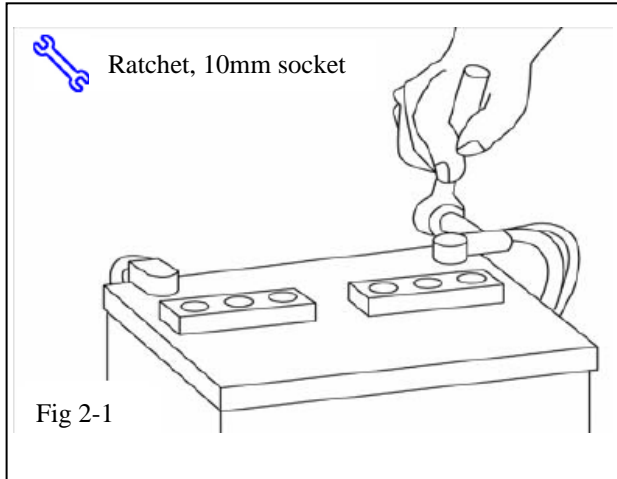

### 1. Precautions

- + (a) Engine components and coolant may be hot, use caution.

### 2. Engine Compartment Parts Removal

- STOP (a) Protect fender before starting.
- (b) Remove battery cable from negative terminal. (Fig. 2-1)

- + (1) Do not touch the positive terminal with any tool when removing cable.

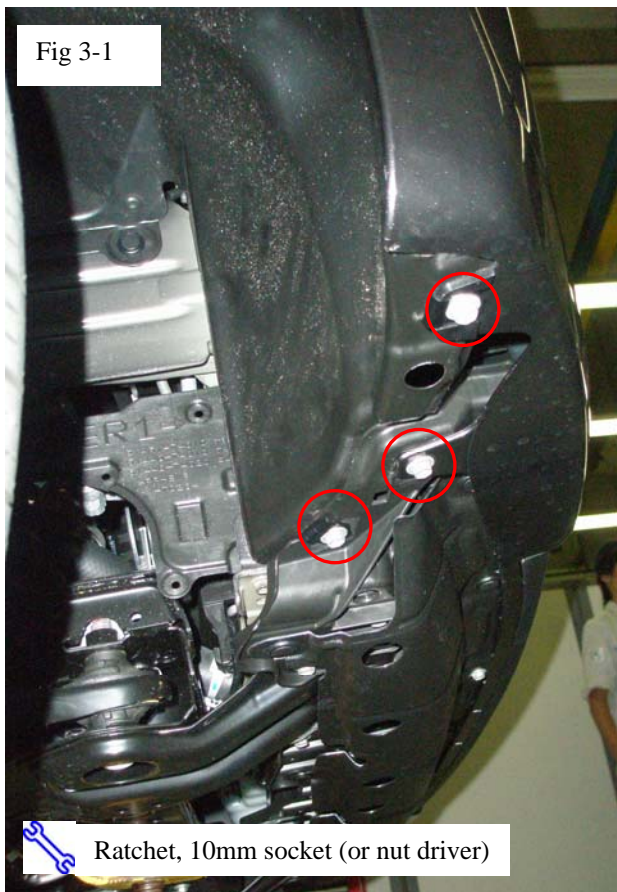

### 3. Exterior Parts Removal

- (a) Remove the 3 circled screws at the bottom of the fender liner. (Fig 3-1, vehicle-right side shown)

- STOP (1) Save all fasteners
- (2) Repeat on other side

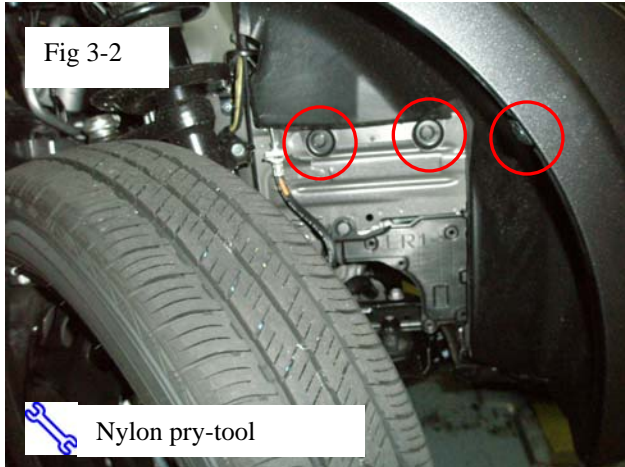

- (b) Remove the 3 circled fasteners inside the fender liner. (Fig 3-2)
- (c) Repeat for other side of vehicle.

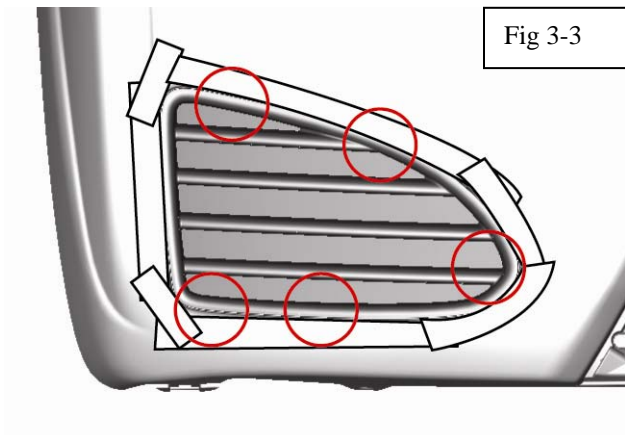

- ⚠ (d) Apply tape to bumper around bezel to protect bumper.
- (e) Remove existing covers; push cover outward, reach underneath bumper and push in snap features at the five circled attachment locations. Snap features are inside the bumper. (Fig 3-3)
- ⚠ (1) Be sure not to damage bumper fascia or fender liner.
- (f) Repeat for other side of the vehicle.

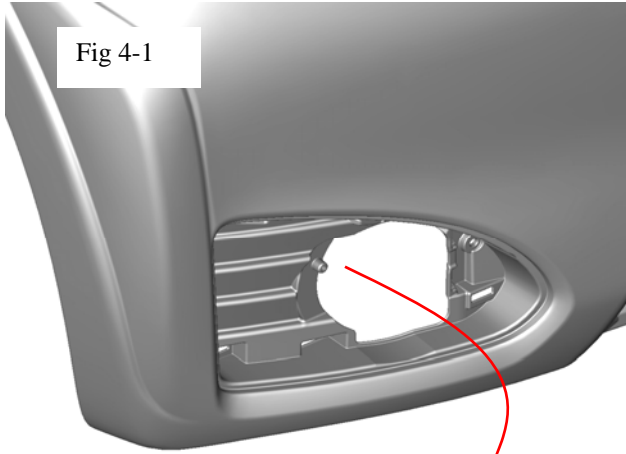

#### 4. Install Fog Lamps and Bezels

- (a) Find fog lamp wire harness inside bezel opening; unwrap tape from around fog lamp wire. (Fig 4-1)

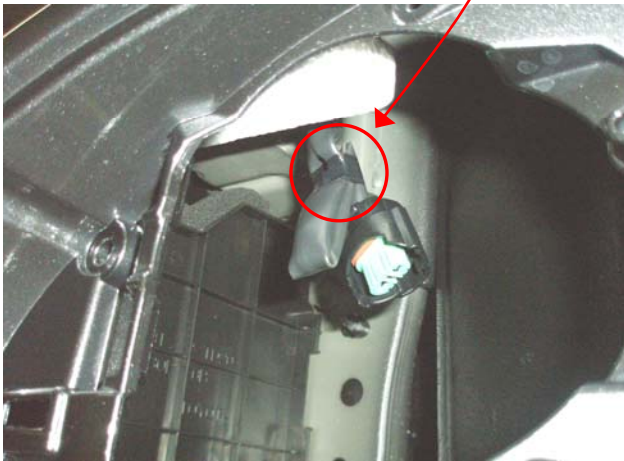

- (b) Plug wire harness into fog lamp. (Fig 4-2)

-  (1) Make sure that wire harness connector is securely attached to fog lamp.

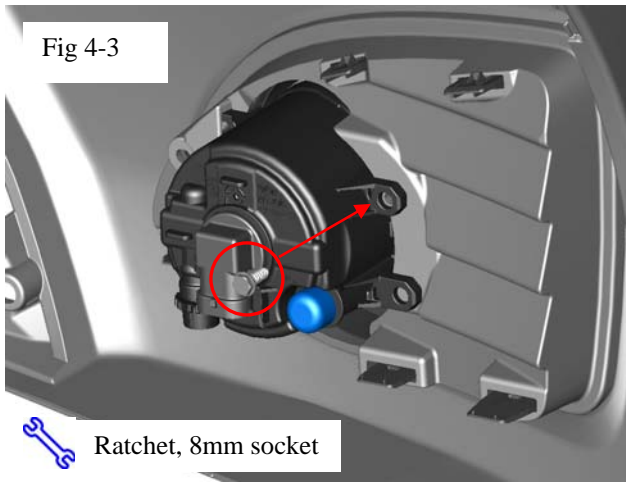

(c) Install self-threading screw (included with kit) through hole and into bumper from the rear. (Fig 4-3, right side shown)

 (1) Fender liner does not get removed. Do not damage fender liner while pulling it aside to install screws.

 (2) Do not over-tighten screw, do not use power tools

(d) Repeat for other side of vehicle.

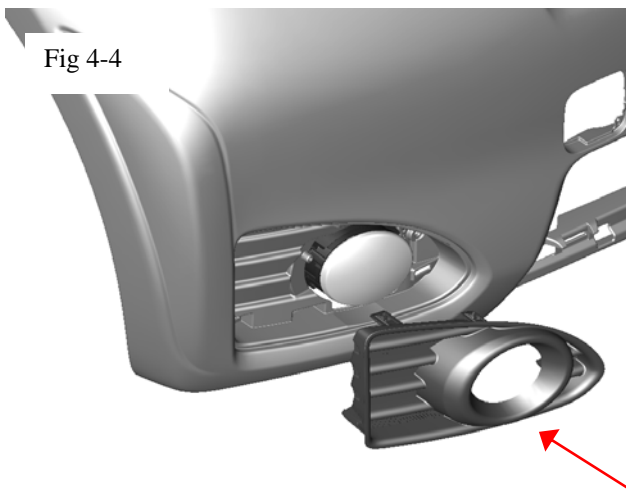

(e) Line up the five snap features in bezel with holes in bumper; press bezel into place. (Fig 4-4)

 (1) Check to make sure part is secure and the snaps have grabbed onto bumper

(f) Repeat for the other side of the vehicle.

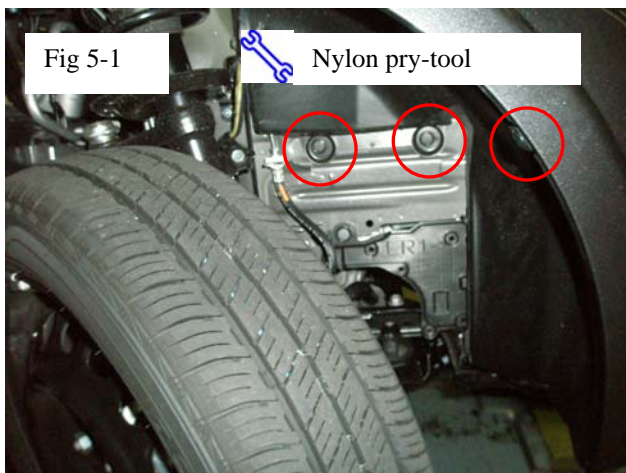

## 5. Reattach Fender Liner

(a) Reattach fender liner near wheel with the three circled fasteners. (Fig 5-1) (If this is a DIO installation, wait until end of installation)



(b) Reattach fender liner under the bumper with the three circled screws. (Fig 5-2) (If this is a DIO installation, wait until end of installation)

(c) Repeat for other side of the vehicle.

Remove tape protecting bumper.

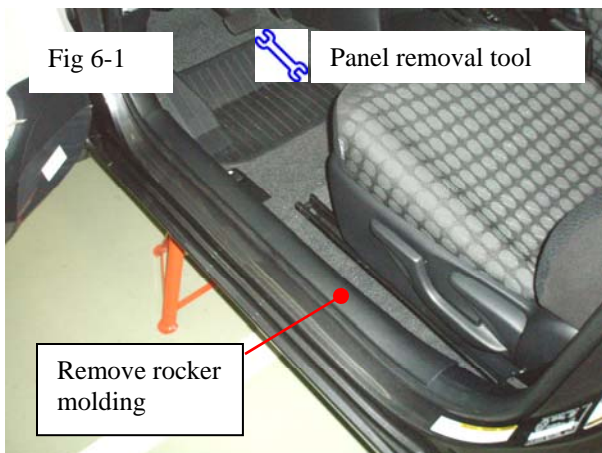

## 6. Relay Installation

(a) Remove molding covering the rocker area (Fig 6-1)

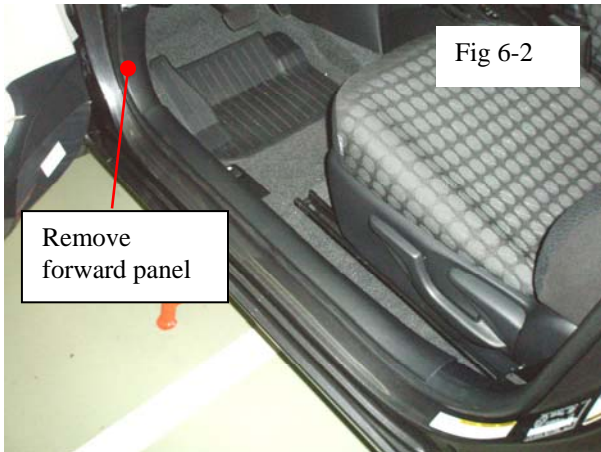

- (b) After removing rocker cover, remove panel forward of the rocker cover molding. (Fig 6-2)

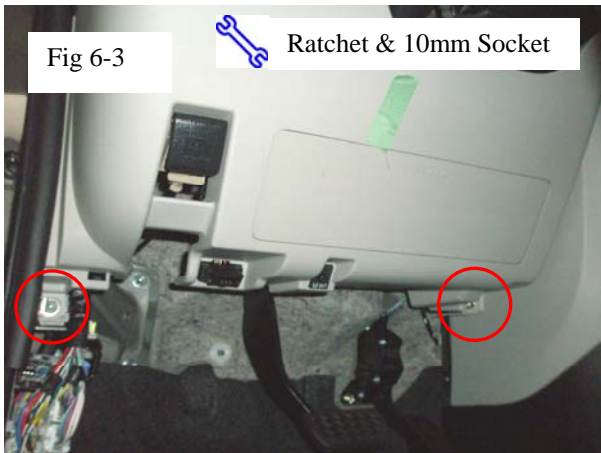

- (c) Remove lower instrument panel cover by removing two screws and pulling cover off. (Fig 6-3)



- (d) Remove circled hood release and connectors to give better access to relay. (Fig 6-4)



(e) Look up under instrument panel from left side (Fig 6-5)

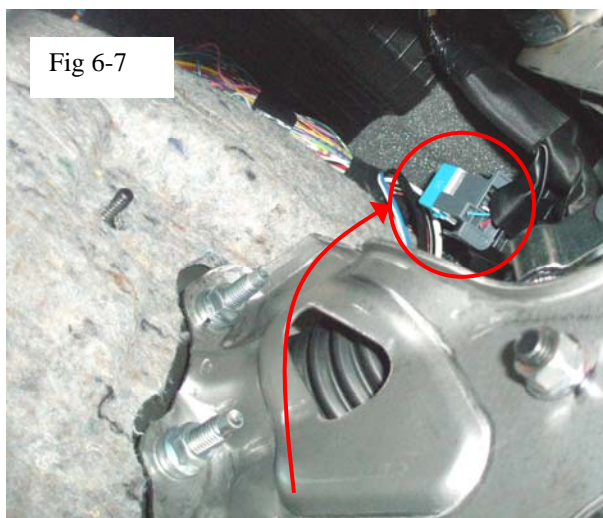
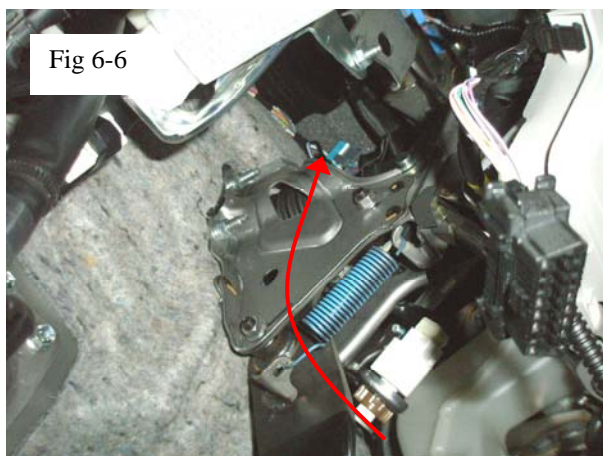

(f) Locate gray receptacle (Fig 6-6 and 6-7). Plug relay into top of this receptacle. The light blue object circled in Figure 6-7 is the relay in the installed position.



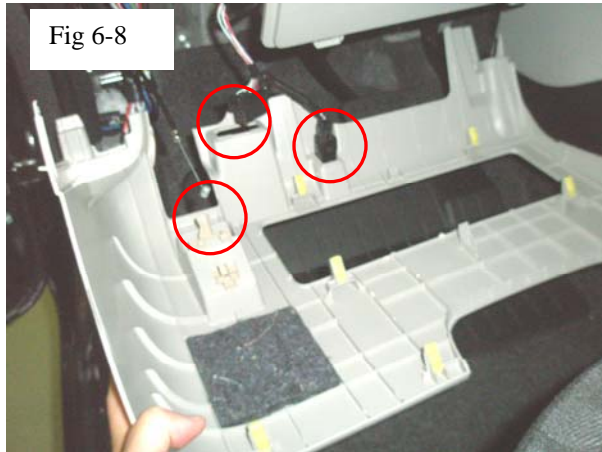

(g) If hood release latch and connectors were disassembled from lower instrument panel cover, reattach them now. (Fig 6-8)

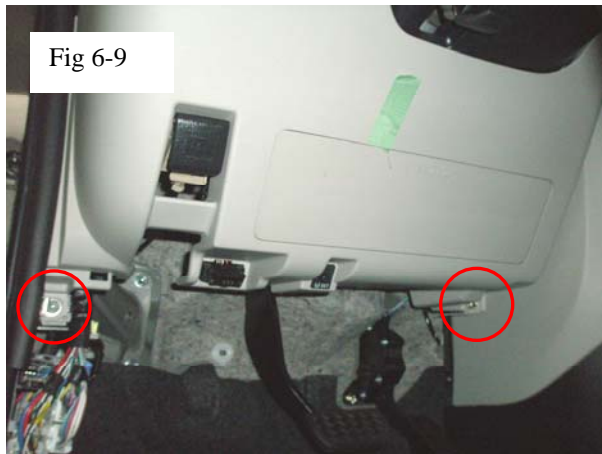

(h) Reassemble lower instrument panel and reinstall the two screws circled in Figure 6-9.

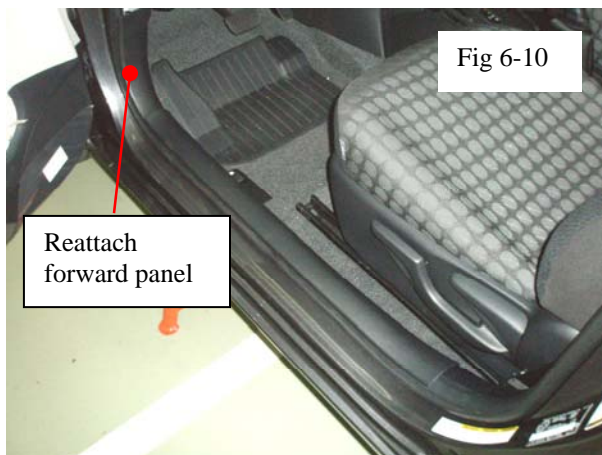

(i) Reattach forward rocker cover molding. (Fig 6-10)

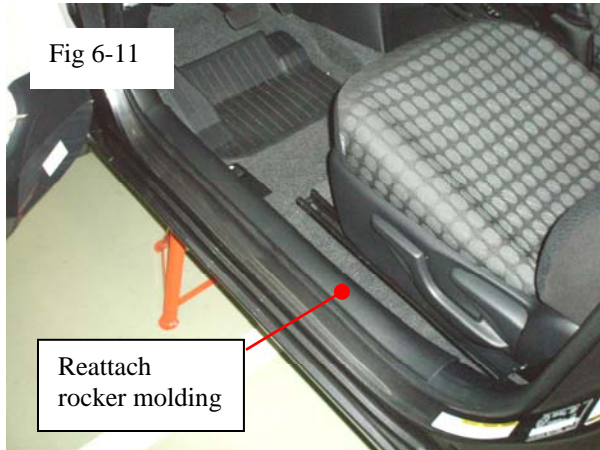

(j) Reattach rocker cover molding. (Fig 6-11)

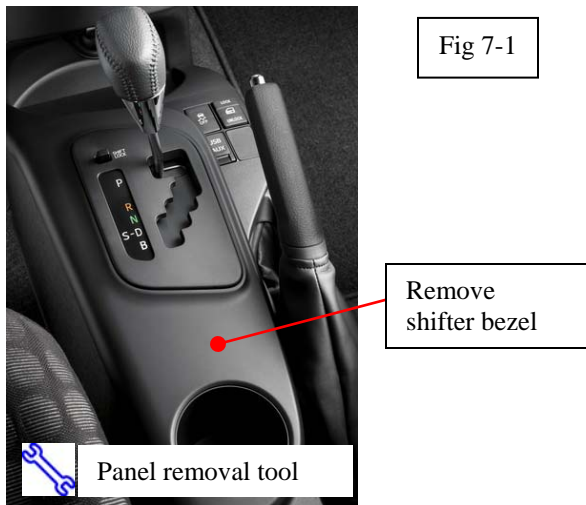

## 7. Switch Installation

(a) Remove bezel from around shifter. (Fig 7-1)

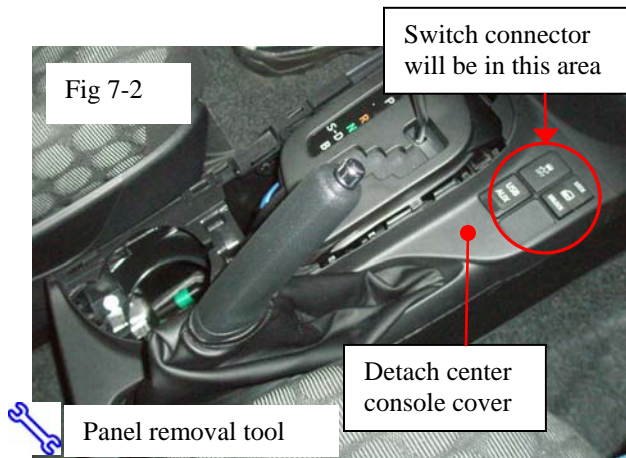

(b) Detach center console cover. (Fig 7-2)

 (1) Connectors leading to switches **do not** need to be disconnected.

(c) Fog light switch connector will be in the forward right portion of console. (Fig 7-2)

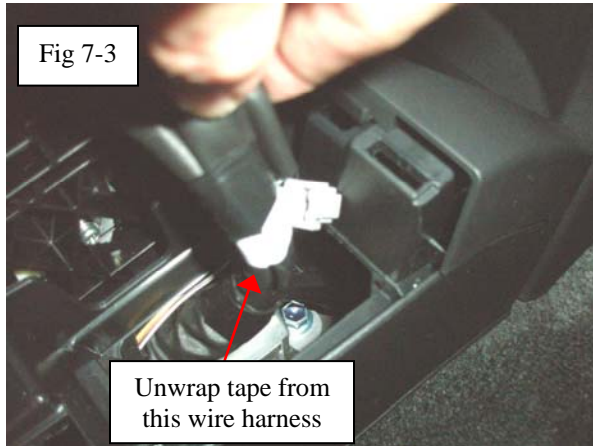

(d) Unwrap tape from around fog light switch wire harness in console. (Fig 7-3)



(e) Remove rear-right knock-out to make room for fog light switch. (Fig 7-4)

(f) Feed fog light wire harness connector through opening and connect it to fog lamp switch (provided with kit) (Fig 7-4)

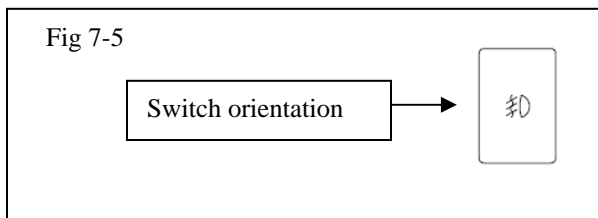

(g) Install switch into opening from Figure 7-4.

**⚠** (1) Switch orientation should be as shown in Figure 7-5.

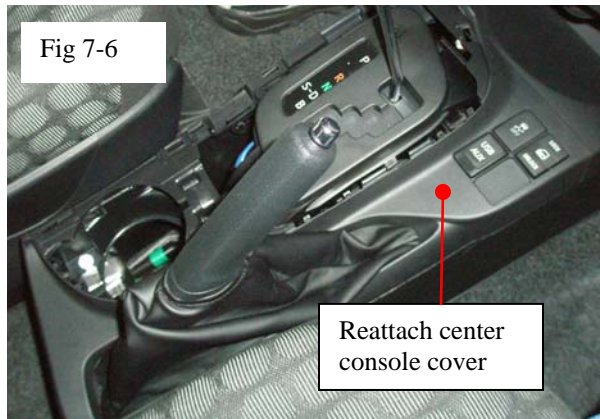

(h) Reattach center console cover (Fig 7-6)

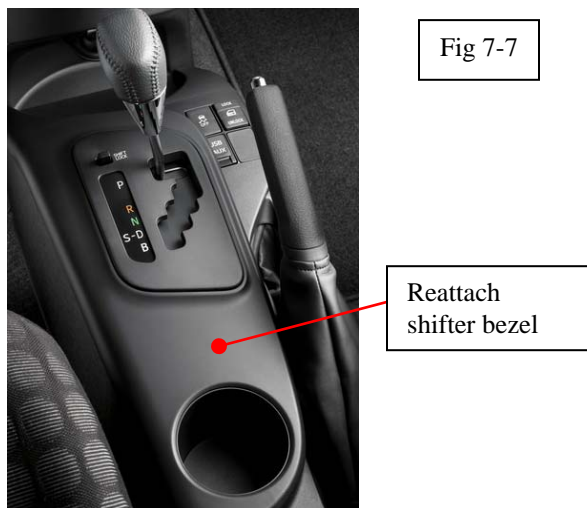

(i) Reattach shifter bezel. (Fig 7-7)

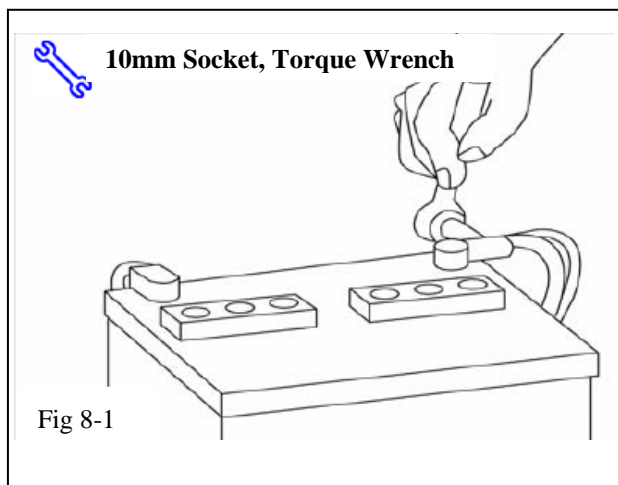

### 8. Reconnect Negative Battery Cable

(a) Attach negative battery cable to negative terminal on battery (Fig 8-1)

**+** (1) Do not touch positive terminal with any tool while reattaching cable.

(b) Tighten the nut to 5.4N-m (48in-lb<sub>f</sub>) **||**

### 9. Aiming Instructions (DIO Only)

(a) Position vehicle on flat surface at a distance of 25 feet (7.6m) from the fog light to the wall (Fig 9-1)

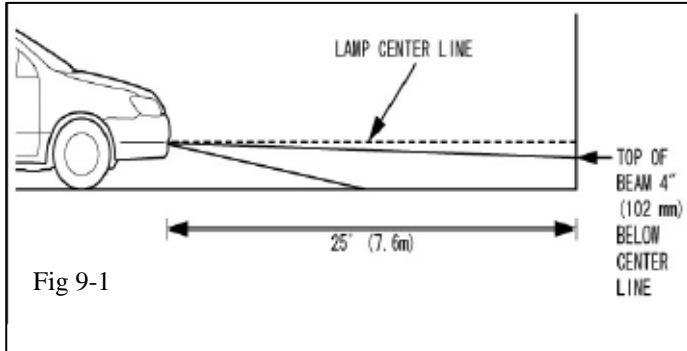

(1) Measure the distance from the center of the lamp to the ground and mark off the same height on the wall. This is your fog light centerline

(2) Adjustment of the fog lights is done by turning the adjustment screw using a Phillips screwdriver. (Fig 9-2)

(3) Turn on the fog lights and adjust them so that the top of the beam (high intensity portion) falls 4 inches (102mm) below the mark on the wall (fog light centerline)



(b) Alternate aiming method: Use Hella Photometric Beam Setter (or equivalent) to correctly align fog light beam. (Fig 9-3)

(1) Adjustment of the fog lights are done by turning the adjustment screw using a Phillips screwdriver. (Fig 9-2)

(c) Repeat for other side of vehicle.

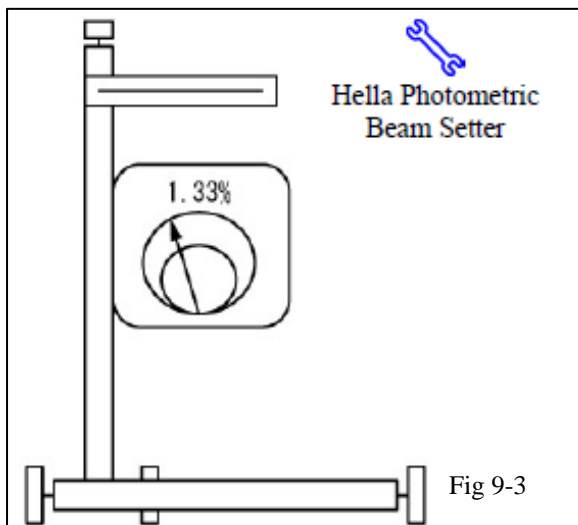

Checklist - these points **MUST** be checked to ensure a quality installation.

Check:

Look For:

Accessory Function Checks

- Turn on headlights
- Turn on fog lights
- Turn off headlights
  
- Check fog light switch orientation
- Switch on high beams
- Check dashboard lights

- Headlights "ON"
- Fog lights "ON"
- Fog lights are not "ON" with headlights "OFF"
  
- Lamp symbol is facing left
- High beams "ON" / Fog lights "OFF"
- Low beams "ON" / Fog lights "ON"

Vehicle Function Checks

- Check taillights.
- Turn off headlights.
- Check brake lights.
- Check turn signals.
- Check reverse lights.
- Check emergency flashers.
- Check mirror controls.
- Check battery terminals for tightness with 10mm socket and torque wrench.

- Taillights "ON"
- Headlights "OFF"
- Brake lights "ON"
- Turn signals "ON"
- Reverse lights "ON"
- Emergency flashers "ON"
- Mirrors can be adjusted
- Terminals are tight (5.4 N-m (48 in-lb<sub>f</sub>))

